

Manual

FIS Incremental Encoder

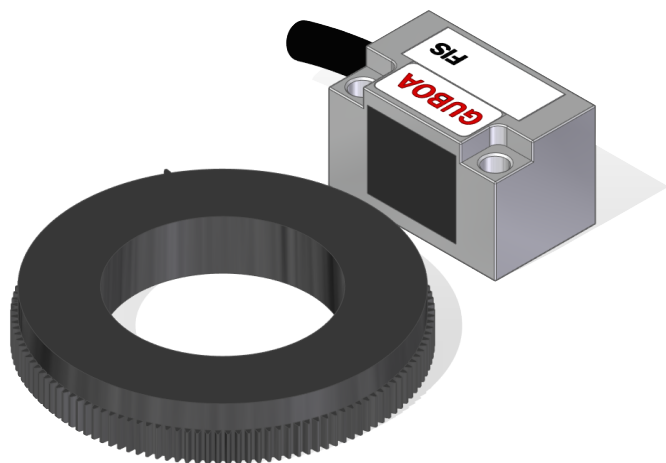

Applications

- Speed and position feedback for high speed spindles, motors, CNC machines

General Information

- Contactless scanning of rotating position and speed.
- Compact design for used in limited space.
- Contact free detection without any mechanical wear problem
- High protecting class IP68.
- Sensing gear wheel from module 0.4 , 1.0
- High response, up to 100,000 rpm

■ Specification

	1 Vpp (A)
Power supply Vcc (DCV)	5 V ± 5%
Load current (open output)	≤ 60 mA
VOH (open -output)	N/A
VOL (open -output)	N/A
Output signal type	Differential Analog (1 Vpp)
Max. Output signal frequency	≥ 150 KHZ
Output signal amplitude	≥ 1 Vpp
A 、 B phase shifting	≤ 90 ± 10°
Sensing gap	0.20 ± 0.03 mm
Operating temperature	-20°C ~ 100°C
Protection rating	IP 68
Approx weight scanning head (g)	90 ± 5%

■ Signal diagram

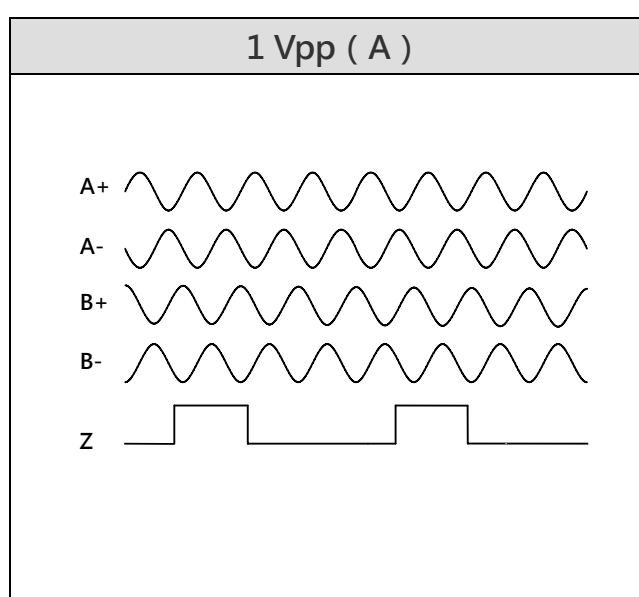

Dimension

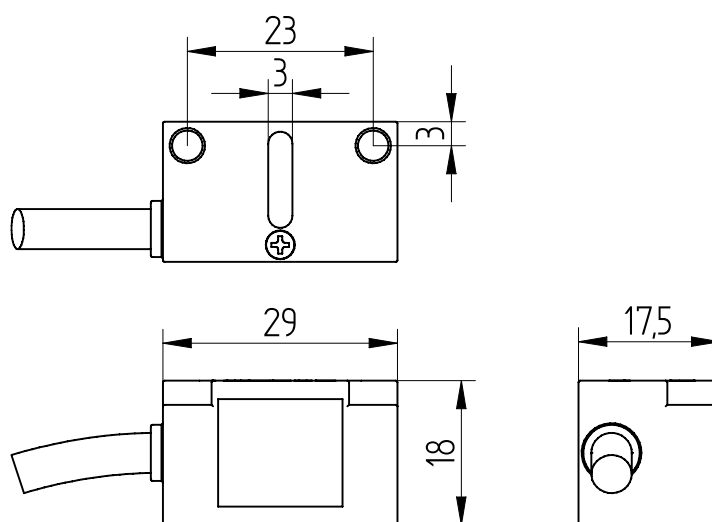

Installation

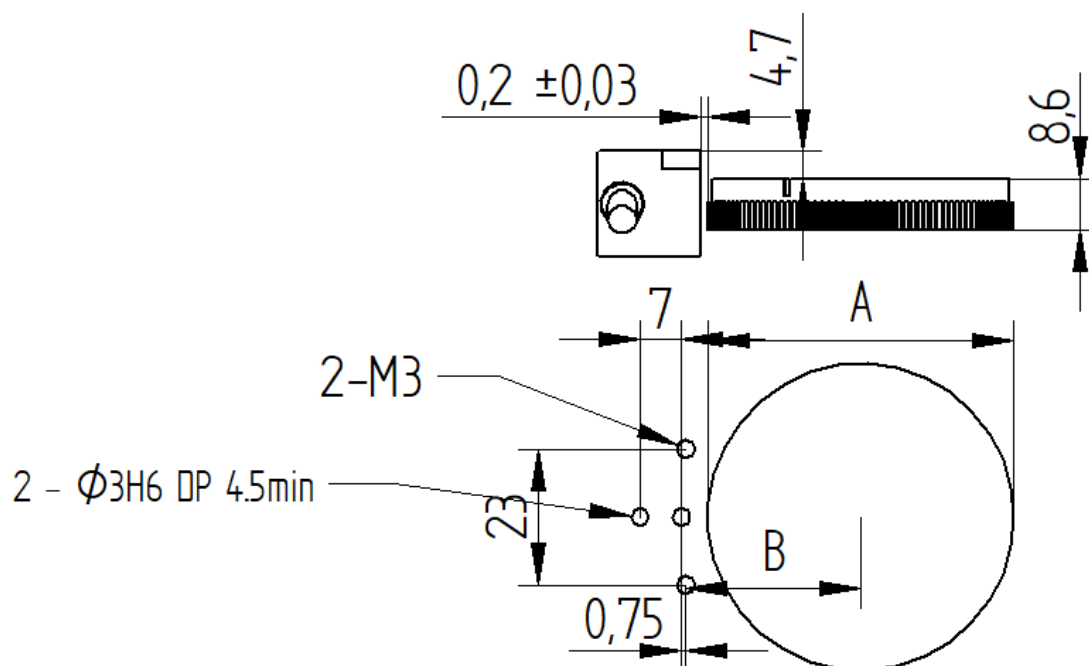

Teeth	96	128	192	256	384	512	640	768
A	39.2	52	77.6	103.2	154.4	205.6	256.8	308
B	22.8	29.2	42	54.8	80.4	106	131.6	157.2

Note: $B = A (OD) / 2 + 3.2 \text{ mm}$

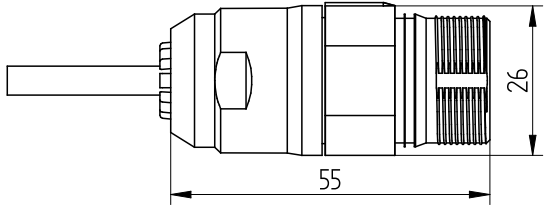
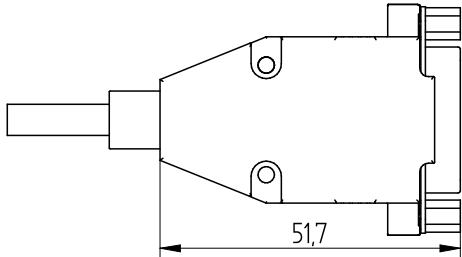
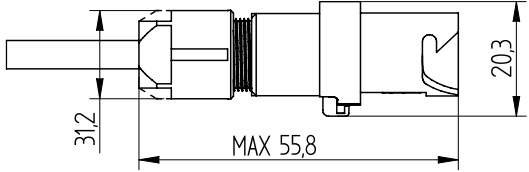
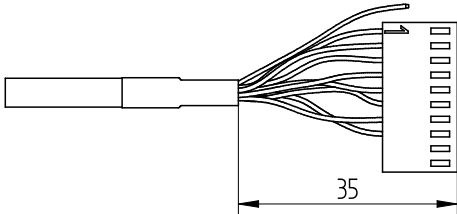
Connector type	code	
<p>M23 12 Pin / 17 Pin</p>	<p>E12 / E17</p>	
<p>D-SUB 15 Pin</p>	<p>D</p>	
<p>JAE 10 Pin</p>	<p>P</p>	
<p>Open-end</p>	<p>N</p>	

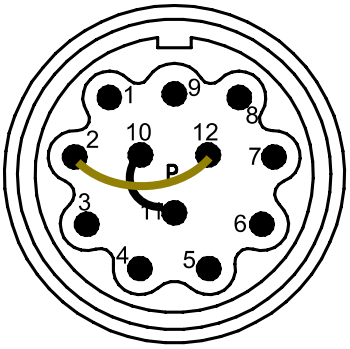
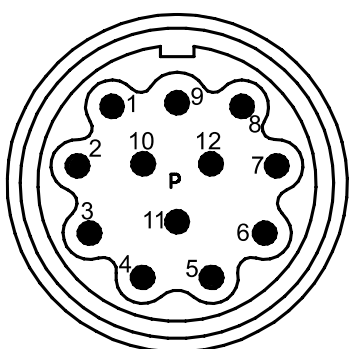
M23 12 Pin				
1Vpp (A)	Pin	Function	Color	TTL (T)
	1	B-	red	
	2	Sensor +	brown	
	3	Z+	grey	
	4	Z-	pink	
	5	A+	green	
	6	A-	yellow	
	7	-		
	8	B+	blue	
	9	-		
	10	GND	white	
	11	Sensor -	white	
	12	V+	brown	

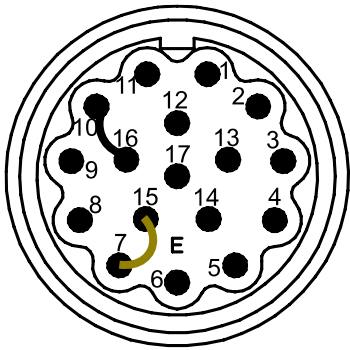
M23 17 Pin	Pin	Function	Color	1Vpp (A)
	1	A	green	A
	2	/A	yellow	/A
	3	Z	grey	Z
	4	-		
	5	-		
	6	-		
	7	GND	white	0V
	8	-		
	9	-		
	10	+ 5V	brown	+ 5V
	11	B	blue	B
	12	/B	red	/B
	13	/Z	pink	/Z
	14	-		
	15	Sensor 0V		
	16	Sensor 5V		
	17	-		
接外格	接地	外部隔離	接地	

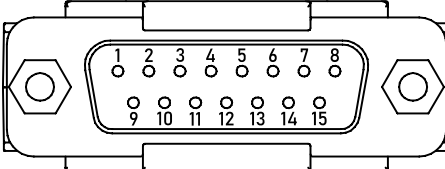
D-SUB 15 Pin	Pin	Function	Color	1Vpp (A)	TTL (T)
	1	Vcc	Brown	Power +5V	Power +5V
	2	GND	White	Power 0V	Power 0V
	3	A+	Green	A+	A+
	4	A-	Yellow	A-	A-
	5	-			
	6	B+	Blue	B+	B+
	7	B-	Red	B-	B-
	8	-			
	9	-			
	10	Z+	Grey	Z+	Z+
	11	-			
	12	Z-	Pink	Z-	Z-
	13	-			
	14	-			
	15	-			

JAE 10pin	Pin	Function	Color	1Vpp (A)	TTL (T)
	1	B+	Green	B+	B+
	2	B-	Yellow	B-	B-
	3	Screen			
	4	V+	Brown	Power +5V	Power +5V
	5	A+	Blue	A+	A+
	6	A-	Red	A-	A-
	7	GND	White	Power 0V	Power 0V
	8	Z+	Grey	Z+	Z+
	9	Z-	pink	Z-	Z-
	10	-			

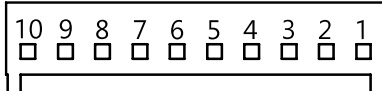
Open-end	Pin	Function	Color	1Vpp (A)	TTL (T)
	1	-			
	2	-			
	3	Z-	Pink	Z-	Z-
	4	Z+	Grey	Z+	Z+
	5	B-	Red	B-	B-
	6	B+	Blue	B+	B+
	7	GND	white	Power 0V	Power 0V
	8	V+	brown	Power +5V	Power +5V
	9	A-	Yellow	A-	A-
	10	A+	green	A+	A+

Encoder model

Encoder type code	
GS XX – A – 01 – FIX – X ① ② ③	
①	Module 04: 0.4 10: 1.0
A 01	Signal type Differential analog (1 Vpp)
②	Cable lenth FIS : 1 m FIL : 3 m
③	Connectors E12 : M23 12 Pin E17 : M23 17 Pin D : D-sub 15 Pin P : JAE 10 pin N : Open end

Encoder type code (FANUC)	
GS 04 - A - 21 – FIX - P ①	
04	Module 0.4
A 21	Compatible signal with FANUC
①	Cable lenth S : 1 m L : 3 m
P	Connectors P : JAE

■ Standard selection table for FIS gear wheel

Specification	OD (A)	ID (B)	PCD (C)	Mounting Hole Diameter (D)	Number of teeth
M4768- 250FS	308	250 $+0/-0.025$	275	8*Ø6.6	768
M4640- 220FS	256.8	220 $+0.02/-0$	230	8*Ø5.5	640
M4512- 160FS	205.6	160 $+0.02/-0$	170	8*Ø5.5	512
M4384- 125FS	154.4	125 $+0.025/-0$	134	8*Ø4.5	384
M4256- 82FS	103.2	82 $+0/-0.018$	n/a	n/a	256
M4192- 60FS	77.6	60 $+0/-0.018$	n/a	n/a	192
M4128- 40FS	52	40 $+0.016/-0$	n/a	n/a	128

Length Unit : mm

